

# PORT REPLICATOR USER'S GUIDE

## ***Notes, Notices, and Cautions***

Throughout this guide, blocks of text may be accompanied by an icon and printed in bold type or in italic type. These blocks are notes, notices, and cautions, and they are used as follows:



*NOTE: A NOTE indicates important information that helps you make better use of your computer system.*

**NOTICE: A NOTICE indicates either potential damage to hardware or loss of data and tells you how to avoid the problem.**



**CAUTION: A CAUTION indicates a potentially hazardous situation which, if not avoided, may result in minor or moderate injury.**

---

**Information in this document is subject to change without notice.  
© 1999 Dell Computer Corporation. All rights reserved.**

Reproduction in any manner whatsoever without the written permission of Dell Computer Corporation is strictly forbidden.

Trademarks used in this text: *Dell*, the *DELL* logo, *BE DIRECT*, *Inspiron*, and *DellWare* are trademarks of Dell Computer Corporation; *Microsoft* and *Windows* are registered trademarks of Microsoft Corporation; *Intel* is a registered trademark of Intel Corporation.

Other trademarks and trade names may be used in this document to refer to either the entities claiming the marks and names or their products. Dell Computer Corporation disclaims any proprietary interest in trademarks and trade names other than its own.

February 2000 P/N 35JMY Rev. A02



# Contents

Connecting External Devices to the Port Replicator . . . . .	1-1
Connecting the Computer to the Port Replicator . . . . .	1-3
APR Buttons and Indicators . . . . .	1-5
Using the APR Power and Undock Buttons . . . . .	1-5
Using the Status Indicators . . . . .	1-5
Detaching the Computer From the Port Replicator . . . . .	1-6
Setting Up the NIC and Networking Software (Optional) . . . . .	1-6
Advanced Port Replicator Setup for Microsoft Windows 98 . . . . .	1-6
Technical Specifications . . . . .	1-8
Regulatory Notices . . . . .	1-9
FCC Notices (U.S. Only) . . . . .	1-10
Class A . . . . .	1-10
Class B . . . . .	1-10
IC Notice (Canada Only) . . . . .	1-11
CE Notice (European Union) . . . . .	1-11
EN 55022 Compliance (Czech Republic Only) . . . . .	1-12
VCCI Notices (Japan Only) . . . . .	1-12
Class A ITE . . . . .	1-12
Class B ITE . . . . .	1-13
MOC Notice (South Korea Only) . . . . .	1-13
Class A Device . . . . .	1-14
Class B Device . . . . .	1-14
Polish Center for Testing and Certification Notice . . . . .	1-14
Wymagania Polskiego Centrum Badań i Certyfikacji . . . . .	1-15
Pozostałe instrukcje bezpieczeństwa . . . . .	1-15
NOM Information (Mexico Only) . . . . .	1-16
Información para NOM (únicamente para México) . . . . .	1-17

Limited Warranty, Return Policy, and Year 2000 Statement of Compliance. . . . .	1-17
Three-Year Limited Warranty (U.S. Only). . . . .	1-17
Coverage During Year One. . . . .	1-18
Coverage During Years Two and Three . . . . .	1-18
General Provisions . . . . .	1-19
Three-Year Limited Warranty (Canada Only) . . . . .	1-19
Coverage During Year One. . . . .	1-20
Coverage During Years Two and Three . . . . .	1-20
General Provisions . . . . .	1-21
One-Year End-User Manufacturer Guarantee (Latin America and the Caribbean Only). . . . .	1-22
Guarantee . . . . .	1-22
Exclusions. . . . .	1-22
Making a Claim . . . . .	1-22
Limitation and Statutory Rights . . . . .	1-22
“Total Satisfaction” Return Policy (U.S. and Canada Only) . . . . .	1-23
Year 2000 Statement of Compliance for Dell-Branded Hardware Products . . . . .	1-24
Previous Products. . . . .	1-24
Software . . . . .	1-25
Additional Information. . . . .	1-25

**Figures**

Figure 1-1. Attaching External Devices to the Port Replicator. . . . .	1-3
Figure 1-2. Positioning the Computer on the Port Replicator . . . . .	1-4
Figure 1-3. Docking the Computer . . . . .	1-4
Figure 1-4. APR Power and Undock Buttons. . . . .	1-5
Figure 1-5. Detaching the Computer From the Port Replicator. . . . .	1-6
Figure 1-6. VCCI Class A ITE Regulatory Mark . . . . .	1-13
Figure 1-7. VCCI Class B ITE Regulatory Mark . . . . .	1-13
Figure 1-8. MOC Class A Regulatory Mark . . . . .	1-14
Figure 1-9. MOC Class B Regulatory Mark . . . . .	1-14

**Tables**

Table 1-1. External Connectors . . . . .	1-1
Table 1-2. Technical Specifications . . . . .	1-8



# Dell™ Inspiron™ 5000 Port Replicator User's Guide

The port replicator integrates your computer quickly and easily into a desktop environment. The advanced port replicator (APR) also includes an integrated network interface controller (NIC) to enable you to connect the computer to a network. Use the instructions in this document to attach external devices to the port replicator and to connect your computer to the port replicator.



*NOTE: If you received a basic input/output system (BIOS) upgrade diskette with your port replicator, use the diskette to upgrade the BIOS on your computer before attaching the computer to the port replicator. For instructions, see the document that came with the BIOS upgrade diskette.*

**NOTICE: Do not attempt to lift the computer while it is docked in the port replicator. Doing so will damage the docking connector. For instructions, refer to “Detaching the Computer From the Port Replicator” found later in this guide.**

## Connecting External Devices to the Port Replicator











The input/output (I/O) connectors on the back of the port replicator duplicate the primary connectors on the back and side of your computer. Table 1-1 shows the icons for each of the connectors on the back of the port replicator and indicates the type of external device(s) that can be attached to each connector.

**Table 1-1. External Connectors**

Connector Icons	External Devices
	The AC adapter that came with the port replicator connects to the AC adapter connector.

*NOTE: For the full name of an abbreviation or acronym used in this table, see the Glossary in the system Help.*

**Table 1-1. External Connectors** (continued)

Connector Icons	External Devices
	An external PS/2-style mouse connects to the PS/2 mouse connector.
	An external PS/2-style keyboard or external numeric keypad connects to the PS/2 keyboard connector.
IOIOI	A serial device, such as a serial mouse or external modem, connects to the serial port connector.
	A parallel device, such as a printer, connects to the parallel port connector.
	An external monitor connects to the monitor connector.
	A television connects to the TV-out S-video connector.
	One or two USB devices, such as a USB mouse, connect to the dual USB connector.
	A network interface cable connects to the NIC connector (APR only). The yellow indicator lights up when connected to 100 Mbps network. The green indicator flashes when data is being transferred.
SPDIF	External speakers or home audio equipment connect to the Sony Phillips Digital Interface (SPDIF) audio output connector.
	Headphones or a speaker connect to the line-out connector.
	A record/playback audio device, such as a cassette player, CD player, or VCR, connects to the line-in connector.
	A microphone connects to the microphone connector.
	

*NOTE: For the full name of an abbreviation or acronym used in this table, see the Glossary in the system Help.*

To attach external devices to the port replicator, perform the following steps.

**NOTICE: The connectors on the back of the port replicator are inverted (as viewed while facing the back of the port replicator). Before attaching any cables, verify that the connector pins are aligned correctly to avoid damaging the connectors.**

1. Refer to Figure 1-1 to attach external devices to the appropriate connectors on the back of the port replicator.



*NOTES: If the cable connector from the external device has thumbscrews, be sure to tighten them to ensure a proper connection.*

*To connect the computer to a network, you must have a network card in your computer. The advanced port replicator has a network card, so another card is not required. However, the pass-through port replicator does not have a network card so you must install a network card in your computer.*

*The port replicators do not provide small computer system interface (SCSI) support. To connect the computer to a SCSI device, you must attach a SCSI card to your computer. See "PC Cards" in the system Help for information about using PC Cards.*

For detailed information on using external devices with your computer, see "Connecting External Devices" in the system Help.

2. Connect the external devices to an electrical outlet, if applicable.

## Connecting the Computer to the Port Replicator

1. Save all open files, and exit all open application programs.
2. Shut down the computer.
3. If you have not already done so, connect the AC adapter to the connector on the port replicator (see Figure 1-1), and plug the AC power cable into an electrical outlet.

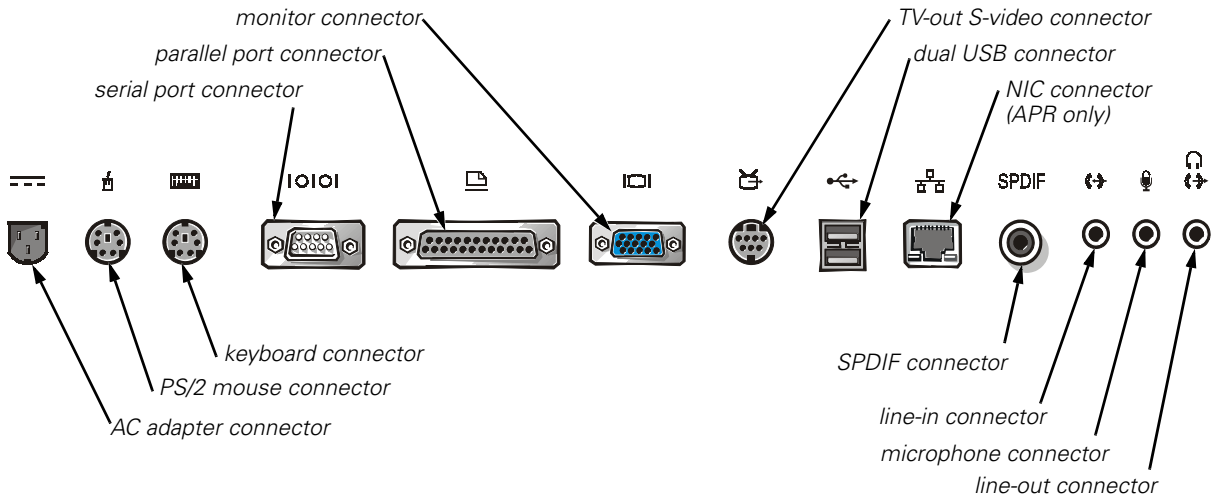

**Figure 1-1. Attaching External Devices to the Port Replicator**

4. Place the computer on the port replicator platform, with the back of the computer facing the port replicator's docking connector, as shown in Figure 1-2.

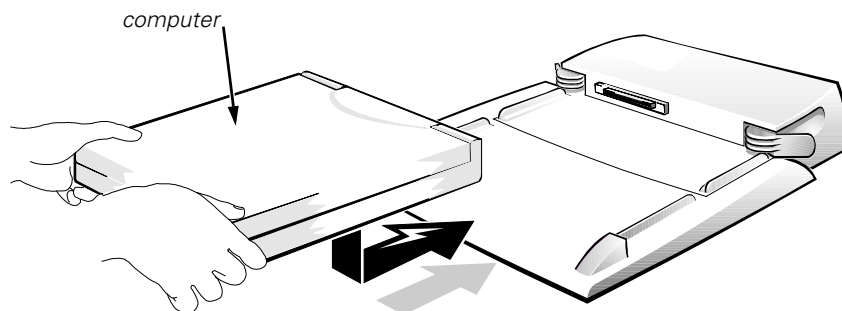

**Figure 1-2. Positioning the Computer on the Port Replicator**

5. Position your fingers on the platform grips, as shown in Figure 1-3, and use your thumbs to push the computer forward until the docking connectors are fully engaged.

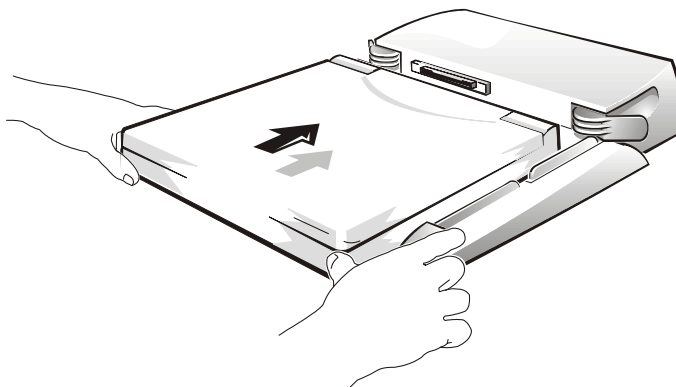

**Figure 1-3. Docking the Computer**

6. Turn on the computer.



## **APR Buttons and Indicators**

The APR features a power button and an undock button, and three status indicators (see Figure 1-4).

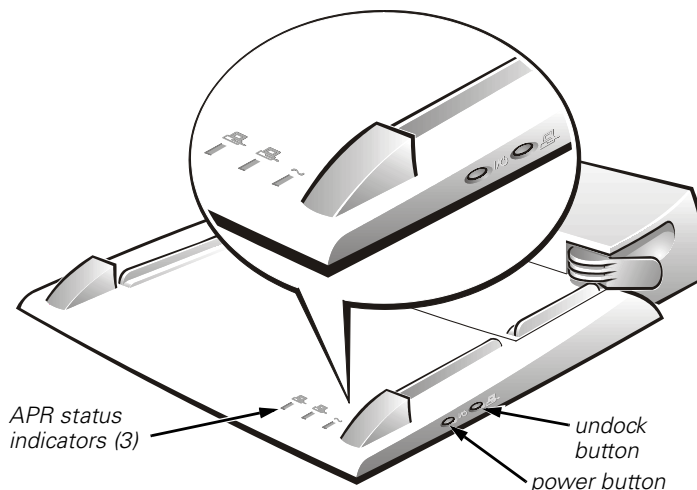

**Figure 1-4. APR Power and Undock Buttons**

### *Using the APR Power and Undock Buttons*

When you receive your APR from Dell, the power button is set to turn your computer on and off. Pressing this button is the equivalent of pressing your computer's power button.

The undock button activates standby mode on the computer so that it may be safely removed from the APR without requiring a restart. When the computer has been detached using the undock button, open the display and press the power button to resume operation.



*NOTE: Do not use the undock button to remove the computer from the APR unless you have a battery installed.*

### *Using the Status Indicators*

The APR has three status indicators (see Figure 1-4). The left indicator turns on when the computer is attached to the APR and is turned on. The center indicator turns on when you press the undock button, or when the computer is placed in standby mode. The right indicator turns on when the APR is connected to an electrical outlet.

## **Detaching the Computer From the Port Replicator**

1. Save all open files, and exit all open application programs.
2. Shut down the computer.
3. Pull both the release handles on the sides of the port replicator, as shown in Figure 1-5, to undock the computer.

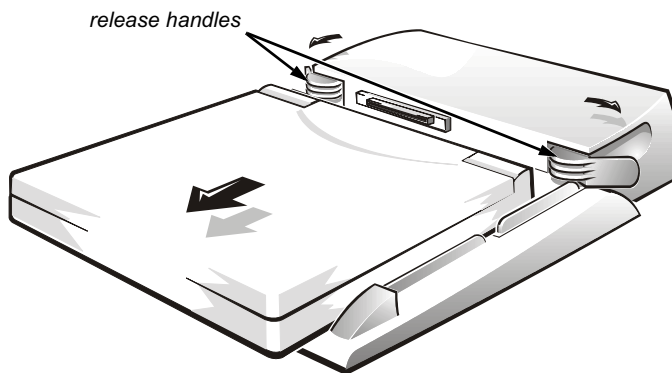

**Figure 1-5. Detaching the Computer From the Port Replicator**

## **Setting Up the NIC and Networking Software (Optional)**

If you purchased the APR with an integrated NIC connector, use the instructions in this section to configure the computer to use the APR with a network.

### **Advanced Port Replicator Setup for Microsoft® Windows® 98**

1. If the computer is on, shut down the operating system and turn off the computer.
2. Disconnect all external devices from the APR.
3. Insert the computer into the APR.
4. Turn on the computer.

The computer automatically detects the NIC and begins the software installation.

5. At the **This wizard searches for new drivers for: Intel 8255x-based PCI Ethernet Adapter (10/100)** dialog box, click **Next**.
6. At the **What do you want Windows to do?** dialog box, click **Search for the best driver for your device (Recommended)**, and then click **Next**.

7. Insert the *Inspiron 5000 Advanced Port Replicator* CD into the CD-ROM or DVD-ROM drive.
8. When asked for the location of the driver, deselect **Floppy disk drives**.
9. Click **Specify a location:**.
10. Type `x:\w98_nic` (where *x*: represents the drive letter of your CD-ROM or DVD-ROM drive), and then click **Next**.
11. At the **What do you want to install?** dialog box, click **The updated driver (Recommended) - Actiontec 82559-based Mini PCI Adapter (10/100)**, and then click **Next**.
12. When Windows displays the message that it is ready to install the driver from **x:\w98\_nic\net82557.inf** (where *x*: represents the drive letter of your CD-ROM or DVD-ROM drive), click **Next**.
13. Click **Finish** when Windows displays a message that the driver is installed.
14. Click **Yes** to restart the computer.
15. After the computer restarts, Windows modifies settings, creates a **Dock 1** configuration, and then displays a `Setup is complete` message.
16. Click **OK**.
17. If the `Updated display settings` message appears, click **OK**.
18. If necessary, consult your network administrator for the steps to configure the network adapter settings.

# Technical Specifications

Table 1-2 lists the technical specifications for the port replicator.

**Table 1-2. Technical Specifications**

<b>Physical</b>	
Height . . . . .	80 mm (3.15 inches)
Depth . . . . .	430.0 mm (16.93 inches)
Width . . . . .	400.0 mm (15.75 inches)
Weight . . . . .	1.44 kg (3.17 lb)
<b>Connectors</b>	
Serial (DTE) . . . . .	9-pin connector
Parallel . . . . .	25-pin connector
PS/2-style keyboard/keypad . . . . .	6-hole external keyboard connector
PS/2-style mouse . . . . .	6-hole external PS/2 mouse connector
Video . . . . .	15-hole connector
Audio . . . . .	one speaker-out jack, one line-in jack, one microphone-in jack
USB (dual) . . . . .	two 4-pin connectors
DC-IN . . . . .	one jack
Docking . . . . .	240-pin connector
SPDIF (RCA) . . . . .	one jack
Network . . . . .	RJ45 connector (APR only)
TV-out . . . . .	S-video connector
<b>Environmental</b>	
Operating temperature . . . . .	0° to 35°C (32° to 95°F)
Storage temperature . . . . .	-20° to 65°C (-4° to 149°F)
Storage relative humidity . . . . .	20% to 90% (noncondensing)
Altitude (Operating) . . . . .	sea level 0–10,000 ft
Altitude (Storage) . . . . .	sea level 0–40,000 ft

*NOTE: For the full name of an abbreviation or acronym used in this table, see the Glossary in the system Help.*

# Regulatory Notices

Electromagnetic Interference (EMI) is any signal or emission, radiated in free space or conducted along power or signal leads, that endangers the functioning of a radio navigation or other safety service or seriously degrades, obstructs, or repeatedly interrupts a licensed radio communications service. Radio communications services include but are not limited to AM/FM commercial broadcast, television, cellular services, radar, air-traffic control, pager, and Personal Communication Services (PCS). These licensed services, along with unintentional radiators such as digital devices, including computer systems, contribute to the electromagnetic environment.

Electromagnetic Compatibility (EMC) is the ability of items of electronic equipment to function properly together in the electronic environment. While this computer system has been designed and determined to be compliant with regulatory agency limits for EMI, there is no guarantee that interference will not occur in a particular installation. If this equipment does cause interference with radio communications services, which can be determined by turning the equipment off and on, you are encouraged to try to correct the interference by one or more of the following measures:

- Reorient the receiving antenna.
- Relocate the computer with respect to the receiver.
- Move the computer away from the receiver.
- Plug the computer into a different outlet so that the computer and the receiver are on different branch circuits.

If necessary, consult a Technical Support representative of Dell Computer Corporation or an experienced radio/television technician for additional suggestions. You may find the *FCC Interference Handbook, 1986*, to be helpful. It is available from the U.S. Government Printing Office, Washington, DC 20402, Stock No. 004-000-00450-7 or on the World Wide Web at <http://www.fcc.gov/Bureaus/Compliance/WWW/tvibook.html>.

Dell computer systems are designed, tested, and classified for their intended electromagnetic environment. These electromagnetic environment classifications generally refer to the following harmonized definitions:

- Class A is for business or industrial environments.
- Class B is for residential environments.

Information Technology Equipment (ITE), including peripherals, expansion cards, printers, input/output (I/O) devices, monitors, and so on, that are integrated into or connected to the system should match the electromagnetic environment classification of the computer system.

**A Notice About Shielded Signal Cables: Use only shielded cables for connecting peripherals to any Dell device to reduce the possibility of interference with radio communications services. Using shielded cables ensures that you maintain the appropriate EMC classification for the intended environment. For parallel printers, a cable is available from Dell Computer Corporation. If you prefer, you can order a cable from Dell**

**Computer Corporation on the World Wide Web at <http://gigabuys.us.dell.com/store/index.asp>.**

Most Dell computer systems are classified for Class B environments. To determine the electromagnetic classification for your system or device, refer to the following sections specific for each regulatory agency. Each section provides country-specific EMC/EMI or product safety information.

### **FCC Notices (U.S. Only)**

Most Dell computer systems are classified by the Federal Communications Commission (FCC) as Class B digital devices. However, the inclusion of certain options can change the rating of some configurations to Class A. To determine which classification applies to your computer system, examine all FCC registration labels located on the bottom or back panel of your computer, on card-mounting brackets, and on the cards themselves. If any one of the labels carries a Class A rating, your entire system is considered to be a Class A digital device. If *all* labels carry either the Class B rating distinguished by either an FCC ID number or the FCC logo, (**FCC**), your system is considered to be a Class B digital device.

Once you have determined your system's FCC classification, read the appropriate FCC notice. Note that FCC regulations provide that changes or modifications not expressly approved by Dell Computer Corporation could void your authority to operate this equipment.

This device complies with Part 15 of the FCC Rules. Operation is subject to the following two conditions:

- This device may not cause harmful interference.
- This device must accept any interference received, including interference that may cause undesired operation.

### **Class A**

This equipment has been tested and found to comply with the limits for a Class A digital device pursuant to Part 15 of the FCC Rules. These limits are designed to provide reasonable protection against harmful interference when the equipment is operated in a commercial environment. This equipment generates, uses, and can radiate radio frequency energy and, if not installed and used in accordance with the manufacturer's instruction manual, may cause harmful interference with radio communications. Operation of this equipment in a residential area is likely to cause harmful interference, in which case you will be required to correct the interference at your own expense.

### **Class B**

This equipment has been tested and found to comply with the limits for a Class B digital device pursuant to Part 15 of the FCC Rules. These limits are designed to provide reasonable protection against harmful interference in a residential installation. This equipment generates, uses, and can radiate radio frequency energy and, if not installed and used in accordance with the manufacturer's instruction manual, may cause interference with radio communications. However, there is no guarantee that

interference will not occur in a particular installation. If this equipment does cause harmful interference to radio or television reception, which can be determined by turning the equipment off and on, you are encouraged to try to correct the interference by one or more of the following measures:

- Reorient or relocate the receiving antenna.
- Increase the separation between the equipment and the receiver.
- Connect the equipment into an outlet on a circuit different from that to which the receiver is connected.
- Consult the dealer or an experienced radio/television technician for help.

The following information is provided on the device or devices covered in this document in compliance with FCC regulations:

- Model number: TSR9P/TSR9PS
- Company name: Dell Computer Corporation  
EMC Engineering Department  
One Dell Way  
Round Rock, Texas 78682 USA  
512-338-4400

### **IC Notice (Canada Only)**

Most Dell portable computers (and other Dell digital apparatus) are classified by the Industry Canada (IC) Interference-Causing Equipment Standard #3 (ICES-003) as Class B digital devices. To determine which classification (Class A or B) applies to your computer system (or other Dell digital apparatus), examine all registration labels located on the bottom or the back panel of your computer (or other digital apparatus). A statement in the form of "IC Class A ICES-003" or "IC Class B ICES-003" will be located on one of these labels. Note that Industry Canada regulations provide that changes or modifications not expressly approved by Dell Computer Corporation could void your authority to operate this equipment.

This Class B (or Class A, if so indicated on the registration label) digital apparatus meets the requirements of the Canadian Interference-Causing Equipment Regulations.

Cet appareil numérique de la Classe B (ou Classe A, si ainsi indiqué sur l'étiquette d'enregistrement) respecte toutes les exigences du Règlement sur le Matériel Brouilleur du Canada.

### **CE Notice (European Union)**

Marking by the symbol  indicates compliance of this Dell system to the EMC Directive and the Low Voltage Directive of the European Union. Such marking is indicative that this Dell system meets the following technical standards:

- EN 55022 — "Limits and Methods of Measurement of Radio Interference Characteristics of Information Technology Equipment."



- EN 50082-1: 1992 — “Electromagnetic compatibility—Generic immunity standard Part 1: Residential, commercial, and light industry.”
- EN 60950 — “Safety of Information Technology Equipment.”

*NOTE: EN 55022 emissions requirements provide for two classifications:*

- *Class A is for typical commercial areas.*
- *Class B is for typical domestic areas.*

This Dell device is classified for use in a typical Class B domestic environment.

A “Declaration of Conformity” in accordance with the preceding directives and standards has been made and is on file at Dell Products Europe BV, Limerick, Ireland.

## **EN 55022 Compliance (Czech Republic Only)**

This device belongs to Class B devices as described in EN 55022, unless it is specifically stated that it is a Class A device on the specification label. The following applies to devices in Class A of EN 55022 (radius of protection up to 30 meters). The user of the device is obliged to take all steps necessary to remove sources of interference to telecommunication or other devices.

Pokud není na typovém štítku počítače uvedeno, že spadá do třídy A podle EN 55022, spadá automaticky do třídy B podle EN 55022. Pro zařízení zařazená do třídy A (ochranné pásmo 30m) podle EN 55022 platí následující. Dojde-li k rušení telekomunikačních nebo jiných zařízení, je uživatel povinen provést taková opatření, aby rušení odstranil.

## **VCCI Notices (Japan Only)**

Most Dell computer systems are classified by the Voluntary Control Council for Interference (VCCI) as Class B information technology equipment (ITE). However, the inclusion of certain options can change the rating of some configurations to Class A. ITE, including peripherals, expansion cards, printers, input/output (I/O) devices, monitors, and so on, integrated into or connected to the system, should match the electromagnetic environment classification (Class A or B) of the computer system.

To determine which classification applies to your computer system, examine the regulatory labels/markings (see Figures 1-6 and 1-7) located on the bottom or back panel of your computer. Once you have determined your system’s VCCI classification, read the appropriate VCCI notice.

### **Class A ITE**

この装置は、情報処理装置等電波障害自主規制協議会 (VCCI) の基準に基づくクラス A 情報技術装置です。この装置を家庭環境で使用すると電波妨害を引き起こすことがあります。この場合には使用者が適切な対策を講ずるよう要求されることがあります。



This is a Class A product based on the standard of the Voluntary Control Council for Interference (VCCI) for information technology equipment. If this equipment is used in a domestic environment, radio disturbance may arise. When such trouble occurs, the user may be required to take corrective actions.

## VCCI-A

### Figure 1-6. VCCI Class A ITE Regulatory Mark

#### Class B ITE

この装置は、情報処理装置等電波障害自主規制協議会 (VCCI) の基準に基づくクラス B 情報技術装置です。この装置は家庭環境で使用することを目的としていますが、この装置がラジオやテレビジョン受信機に近接して使用させると、受信障害を引き起こすことがあります。取扱説明書に従って正しい取り扱いをして下さい。

This is a Class B product based on the standard of the Voluntary Control Council for Interference (VCCI) for information technology equipment. If this equipment is used near a radio or television receiver in a domestic environment, it may cause radio interference. Install and use the equipment according to the instruction manual.



### Figure 1-7. VCCI Class B ITE Regulatory Mark

#### MOC Notice (South Korea Only)

To determine which classification (Class A or B) applies to your computer system (or other Dell digital device), examine the South Korean Ministry of Communications (MOC) registration labels located on your computer (or other Dell digital device). The MOC label may be located separately from the other regulatory marking applied to your product. The English text, "EMI (A)," for Class A products, or "EMI (B)" for Class B products, appears in the center of the MOC label (see Figures 1-8 and 1-9).



*NOTE: MOC emissions requirements provide for two classifications:*

- *Class A devices are for business purposes.*
- *Class B devices are for nonbusiness purposes.*

## Class A Device

장치 종류	사용자 안내문
A급 기기	이 장치는 업무용으로 전자파 적합등록을 한 장치이오니 판매자 또는 사용자는 이 점을 주의하시기 바라며 만약 잘못 판매 또는 구입하였을 때에는 가정용으로 교환하시기 바랍니다.

Please note that this device has been approved for business purposes with regard to electromagnetic interference. If you find that this device is not suitable for your use, you may exchange it for a nonbusiness device.

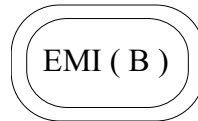

**Figure 1-8. MOC Class A Regulatory Mark**

## Class B Device

장치 종류	사용자 안내문
B급 기기	이 장치는 가정용으로 전자파 적합등록을 한 장치로서 주거지역에서는 물론 모든 지역에서 사용할 수 있습니다.

Please note that this device has been approved for nonbusiness purposes and may be used in any environment, including residential areas.



**Figure 1-9. MOC Class B Regulatory Mark**

## **Polish Center for Testing and Certification Notice**

The equipment should draw power from a socket with an attached protection circuit (a three-prong socket). All equipment that works together (computer, monitor, printer, and so on) should have the same power supply source.

The phasing conductor of the room's electrical installation should have a reserve short-circuit protection device in the form of a fuse with a nominal value no larger than 16 amperes (A).

To completely switch off the equipment, the power supply cable must be removed from the power supply socket, which should be located near the equipment and easily accessible.

A protection mark "B" confirms that the equipment is in compliance with the protection usage requirements of standards PN-93/T-42107 and PN-EN55022:1996.

### ***Wymagania Polskiego Centrum Badań i Certyfikacji***

Urządzenie powinno być zasilane z gniazda z przyłączonym obwodem ochronnym (gniazdo z kołkiem). Współpracujące ze sobą urządzenia (komputer, monitor, drukarka) powinny być zasilane z tego samego źródła.

Instalacja elektryczna pomieszczenia powinna zawierać w przewodzie fazowym rezerwową ochronę przed zwarciami, w postaci bezpiecznika o wartości znamionowej nie większej niż 16A (amperów).

W celu całkowitego wyłączenia urządzenia z sieci zasilania, należy wyjąć wtyczkę kabla zasilającego z gniazda, które powinno znajdować się w pobliżu urządzenia i być łatwo dostępne.

Znak bezpieczeństwa "B" potwierdza zgodność urządzenia z wymaganiami bezpieczeństwa użytkownika zawartymi w PN-93/T-42107 i PN-89/E-06251.

### ***Pozostałe instrukcje bezpieczeństwa***

- Nie należy używać wtyczek adapterowych lub usuwać kołka obwodu ochronnego z wtyczki. Jeżeli konieczne jest użycie przedłużacza to należy użyć przedłużacza 3-żyłowego z prawidłowo połączonym przewodem ochronnym.
- System komputerowy należy zabezpieczyć przed nagłymi, chwilowymi wzrostami lub spadkami napięcia, używając eliminatora przepięć, urządzenia dopasowującego lub bezzakłócenowego źródła zasilania.
- Należy upewnić się, aby nic nie leżało na kablach systemu komputerowego, oraz aby kable nie były umieszczone w miejscu, gdzie można byłoby na nie nadeptywać lub potykać się o nie.
- Nie należy rozlewać napojów ani innych płynów na system komputerowy.
- Nie należy wpychać żadnych przedmiotów do otworów systemu komputerowego, gdyż może to spowodować pożar lub porażenie prądem, poprzez zwarcie elementów wewnętrznych.
- System komputerowy powinien znajdować się z dala od grzejników i źródeł ciepła. Ponadto, nie należy blokować otworów wentylacyjnych. Należy unikać kładzenia luźnych papierów pod komputer oraz umieszczania komputera w ciasnym miejscu bez możliwości cyrkulacji powietrza wokół niego.

## **NOM Information (Mexico Only)**

The following information is provided on the device(s) described in this document in compliance with the requirements of the official Mexican standards (NOM):

Exporter:	Dell Computer Corporation One Dell Way Round Rock, TX 78682
Importer:	Dell Computer de México, S.A. de C.V. Rio Lerma No. 302 - 4° Piso Col. Cuauhtemoc 16500 México, D.F.
Ship to:	Dell Computer de México, S.A. de C.V. al Cuidado de Kuehne & Nagel de México S. de R.I. Avenida Soles No. 55 Col. Peñon de los Baños 15520 México, D.F.
Supply voltage:	100–240 VAC
Frequency:	50–60 Hz
Current consumption:	1.5 A

## **Información para NOM (únicamente para México)**

La información siguiente se proporciona en el dispositivo o en los dispositivos descritos en este documento, en cumplimiento con los requisitos de la Norma Oficial Mexicana (NOM):

Exportador:	Dell Computer Corporation One Dell Way Round Rock, TX 78682
Importador:	Dell Computer de México, S.A. de C.V. Rio Lerma No. 302 - 4° Piso Col. Cuauhtemoc 16500 México, D.F.
Embarcar a:	Dell Computer de México, S.A. de C.V. al Cuidado de Kuehne & Nagel de México S. de R.L. Avenida Soles No. 55 Col. Peñon de los Baños 15520 México, D.F.
Tensión alimentación:	100–240 VAC
Frecuencia:	50–60 Hz
Consumo de corriente:	1.5 A

## **Limited Warranty, Return Policy, and Year 2000 Statement of Compliance**

### **Three-Year Limited Warranty (U.S. Only)**

Dell Computer Corporation (“Dell”) manufactures its hardware products from parts and components that are new or equivalent to new in accordance with industry-standard practices. Dell warrants that the hardware products it manufactures will be free from defects in materials and workmanship. The limited warranty term is three years beginning on the date of invoice, as described in the following text.

Damage due to shipping the products to you is covered under this limited warranty. Otherwise, this limited warranty does not cover damage due to external causes, including accident, abuse, misuse, problems with electrical power, servicing not authorized by Dell, usage not in accordance with product instructions, failure to perform required preventive maintenance, and problems caused by use of parts and components not supplied by Dell.

This limited warranty does not cover any items that are in one or more of the following categories: software; external devices (except as specifically noted); accessories or parts added to a Dell system after the system is shipped from Dell; accessories or parts added to a Dell system through Dell's system integration department; accessories or parts that are not installed in the Dell factory; or DellWare™ products. Monitors, keyboards, and mice that are Dell-branded or that are included on Dell's standard price list are covered under this limited warranty; all other monitors, keyboards, and mice (including those sold through the DellWare program) are not covered. Batteries for portable computers are covered only during the initial one-year period of this limited warranty.

### **Coverage During Year One**

During the one-year period beginning on the invoice date, Dell will repair or replace products covered under this limited warranty that are returned to Dell's facility. To request warranty service, you must call Dell's Customer Technical Support within the warranty period. Refer to the chapter titled "Getting Help" in your system's troubleshooting documentation or, for some systems, the section titled "Contacting Dell" in your system's online guide to find the appropriate telephone number for obtaining customer assistance. If warranty service is required, Dell will issue a Return Material Authorization Number. You must ship the products back to Dell in their original or equivalent packaging, prepay shipping charges, and insure the shipment or accept the risk of loss or damage during shipment. Dell will ship the repaired or replacement products to you freight prepaid if you use an address in the continental U.S., where applicable. Shipments to other locations will be made freight collect.



*NOTE: Before you ship the product(s) to Dell, back up the data on the hard-disk drive(s) and any other storage device(s) in the product(s). Remove any removable media, such as diskettes, CDs, or PC Cards. Dell does not accept liability for lost data or software.*

Dell owns all parts removed from repaired products. Dell uses new and reconditioned parts made by various manufacturers in performing warranty repairs and building replacement products. If Dell repairs or replaces a product, its warranty term is not extended.

### **Coverage During Years Two and Three**

During the second and third years of this limited warranty, Dell will provide, on an exchange basis and subject to Dell's Exchange Policy in effect on the date of the exchange, replacement parts for the Dell hardware product(s) covered under this limited warranty when a part requires replacement. You must report each instance of hardware failure to Dell's Customer Technical Support in advance to obtain Dell's concurrence that a part should be replaced and to have Dell ship the replacement part. Dell will ship parts (freight prepaid) if you use an address in the continental U.S., where applicable. Shipments to other locations will be made freight collect. Dell will include a prepaid shipping container with each replacement part for your use in returning the replaced part to Dell. Replacement parts are new or reconditioned. Dell may provide replacement parts made by various manufacturers when supplying parts to you. The warranty term for a replacement part is the remainder of the limited warranty term.

You will pay Dell for replacement parts if the replaced part is not returned to Dell. The process for returning replaced parts, and your obligation to pay for replacement parts if you do not return the replaced parts to Dell, will be in accordance with Dell's Exchange Policy in effect on the date of the exchange.

You accept full responsibility for your software and data. Dell is not required to advise or remind you of appropriate backup and other procedures.

### **General Provisions**

THIS LIMITED WARRANTY GIVES YOU SPECIFIC LEGAL RIGHTS WHICH VARY FROM STATE TO STATE (OR JURISDICTION TO JURISDICTION). DELL'S RESPONSIBILITY FOR MALFUNCTIONS AND DEFECTS IN HARDWARE IS LIMITED TO REPAIR AND REPLACEMENT AS SET FORTH IN THIS LIMITED WARRANTY STATEMENT. ALL EXPRESS AND IMPLIED WARRANTIES FOR THE PRODUCT, INCLUDING BUT NOT LIMITED TO ANY IMPLIED WARRANTIES OF AND CONDITIONS OF MERCHANTABILITY AND FITNESS FOR A PARTICULAR PURPOSE, ARE LIMITED IN DURATION TO THE WARRANTY PERIOD SET FORTH ABOVE AND NO WARRANTIES, WHETHER EXPRESS OR IMPLIED, WILL APPLY AFTER SUCH PERIOD.

SOME STATES (OR JURISDICTIONS) DO NOT ALLOW LIMITATIONS ON HOW LONG AN IMPLIED WARRANTY LASTS, SO THE PRECEDING LIMITATION MAY NOT APPLY TO YOU.

DELL DOES NOT ACCEPT LIABILITY BEYOND THE REMEDIES SET FORTH IN THIS LIMITED WARRANTY STATEMENT OR LIABILITY FOR INCIDENTAL OR CONSEQUENTIAL DAMAGES, INCLUDING WITHOUT LIMITATION ANY LIABILITY FOR PRODUCTS NOT BEING AVAILABLE FOR USE OR FOR LOST DATA OR SOFTWARE.

SOME STATES (OR JURISDICTIONS) DO NOT ALLOW THE EXCLUSION OR LIMITATION OF INCIDENTAL OR CONSEQUENTIAL DAMAGES, SO THE PRECEDING EXCLUSION OR LIMITATION MAY NOT APPLY TO YOU.

These provisions apply to Dell's three-year limited warranty only. For provisions of any service contract covering your system, refer to your invoice or the separate service contract that you will receive.

If Dell elects to exchange a system or component, the exchange will be made in accordance with Dell's Exchange Policy in effect on the date of the exchange. In any instance in which Dell issues a Return Material Authorization Number, Dell must receive the product(s) for repair prior to the expiration of the warranty period in order for the repair(s) to be covered by the limited warranty.



*NOTE: If you chose one of the available warranty and service options in place of the standard three-year limited warranty described in the preceding text, the option you chose will be listed on your invoice.*

### **Three-Year Limited Warranty (Canada Only)**

Dell Computer Corporation ("Dell") manufactures its hardware products from parts and components that are new or equivalent to new in accordance with industry-standard practices. Dell warrants that the hardware products it manufactures will be

free from defects in materials and workmanship. The warranty term is three years beginning on the date of invoice, as described in the following text.

Damage due to shipping the products to you is covered under this limited warranty. Otherwise, this limited warranty does not cover damage due to external causes, including accident, abuse, misuse, problems with electrical power, servicing not authorized by Dell, usage not in accordance with product instructions, failure to perform required preventive maintenance, and problems caused by use of parts and components not supplied by Dell.

This limited warranty does not cover any items that are in one or more of the following categories: software; external devices (except as specifically noted); accessories or parts added to a Dell system after the system is shipped from Dell; accessories or parts added to a Dell system through Dell's system integration department; accessories or parts that are not installed in the Dell factory; or DellWare products. Monitors, keyboards, and mice that are Dell-branded or that are included on Dell's standard price list are covered under this limited warranty; all other monitors, keyboards, and mice (including those sold through the DellWare program) are not covered. Batteries for portable computers are covered only during the initial one-year period of this limited warranty.

### **Coverage During Year One**

During the one-year period beginning on the invoice date, Dell will repair or replace products covered under this limited warranty that are returned to Dell's facility. To request warranty service, you must call Dell's Customer Technical Support within the warranty period. Refer to the chapter titled "Getting Help" in your system's troubleshooting documentation or, for some systems, the section titled "Contacting Dell" in your system's online guide to find the appropriate telephone number for obtaining customer assistance. If warranty service is required, Dell will issue a Return Material Authorization Number. You must ship the products back to Dell in their original or equivalent packaging, prepay shipping charges, and insure the shipment or accept the risk of loss or damage during shipment. Dell will ship the repaired or replacement products to you freight prepaid if you use an address in Canada, where applicable. Shipments to other locations will be made freight collect.



*NOTE: Before you ship the product(s) to Dell, back up the data on the hard-disk drive(s) and any other storage device(s) in the product(s). Remove any removable media, such as diskettes, CDs, or PC Cards. Dell does not accept liability for lost data or software.*

Dell owns all parts removed from repaired products. Dell uses new and reconditioned parts made by various manufacturers in performing warranty repairs and building replacement products. If Dell repairs or replaces a product, its warranty term is not extended.

### **Coverage During Years Two and Three**

During the second and third years of this limited warranty, Dell will provide, on an exchange basis and subject to Dell's Exchange Policy in effect on the date of the exchange, replacement parts for the Dell hardware product(s) covered under this limited warranty when a part requires replacement. You must report each instance of



hardware failure to Dell's Customer Technical Support in advance to obtain Dell's concurrence that a part should be replaced and to have Dell ship the replacement part. Dell will ship parts (freight prepaid) if you use an address in Canada, where applicable. Shipments to other locations will be made freight collect. Dell will include a prepaid shipping container with each replacement part for your use in returning the replaced part to Dell. Replacement parts are new or reconditioned. Dell may provide replacement parts made by various manufacturers when supplying parts to you. The warranty term for a replacement part is the remainder of the limited warranty term.

You will pay Dell for replacement parts if the replaced part is not returned to Dell. The process for returning replaced parts, and your obligation to pay for replacement parts if you do not return the replaced parts to Dell, will be in accordance with Dell's Exchange Policy in effect on the date of the exchange.

You accept full responsibility for your software and data. Dell is not required to advise or remind you of appropriate backup and other procedures.

### ***General Provisions***

DELL MAKES NO EXPRESS WARRANTIES OR CONDITIONS BEYOND THOSE STATED IN THIS LIMITED WARRANTY STATEMENT. DELL DISCLAIMS ALL OTHER WARRANTIES AND CONDITIONS, EXPRESS OR IMPLIED, INCLUDING WITHOUT LIMITATION IMPLIED WARRANTIES AND CONDITIONS OF MERCHANTABILITY AND FITNESS FOR A PARTICULAR PURPOSE. SOME STATES (OR JURISDICTIONS) DO NOT ALLOW LIMITATIONS ON IMPLIED WARRANTIES OR CONDITIONS, SO THIS LIMITATION MAY NOT APPLY TO YOU.

DELL'S RESPONSIBILITY FOR MALFUNCTIONS AND DEFECTS IN HARDWARE IS LIMITED TO REPAIR AND REPLACEMENT AS SET FORTH IN THIS LIMITED WARRANTY STATEMENT. THESE WARRANTIES GIVE YOU SPECIFIC LEGAL RIGHTS, AND YOU MAY ALSO HAVE OTHER RIGHTS, WHICH VARY FROM STATE TO STATE (OR JURISDICTION TO JURISDICTION).

DELL DOES NOT ACCEPT LIABILITY BEYOND THE REMEDIES SET FORTH IN THIS LIMITED WARRANTY STATEMENT OR LIABILITY FOR INCIDENTAL OR CONSEQUENTIAL DAMAGES, INCLUDING WITHOUT LIMITATION ANY LIABILITY FOR PRODUCTS NOT BEING AVAILABLE FOR USE OR FOR LOST DATA OR SOFTWARE.

SOME STATES (OR JURISDICTIONS) DO NOT ALLOW THE EXCLUSION OR LIMITATION OF INCIDENTAL OR CONSEQUENTIAL DAMAGES, SO THE PRECEDING EXCLUSION OR LIMITATION MAY NOT APPLY TO YOU.

These provisions apply to Dell's three-year limited warranty only. For provisions of any service contract covering your system, refer to your invoice or the separate service contract that you will receive.

If Dell elects to exchange a system or component, the exchange will be made in accordance with Dell's Exchange Policy in effect on the date of the exchange. In any instance in which Dell issues a Return Material Authorization Number, Dell must receive the product(s) for repair prior to the expiration of the warranty period in order for the repair(s) to be covered by the limited warranty.



*NOTE: If you chose one of the available warranty and service options in place of the standard three-year limited warranty described in the preceding text, the option you chose will be listed on your invoice.*

## **One-Year End-User Manufacturer Guarantee (Latin America and the Caribbean Only)**

### *Guarantee*

Dell Computer Corporation (“Dell”) warrants to the end-user in accordance with the following provisions that its branded hardware products, purchased by the end-user from a Dell company or an authorized Dell distributor in Latin America or the Caribbean will be free from defects in materials, workmanship and design affecting normal use, for a period of one year as of the original purchase date. Products for which proper claims are made will, at Dell’s option, be repaired or replaced at Dell’s expense. Dell owns all parts removed from repaired products. Dell uses new and reconditioned parts made by various manufacturers in performing repairs and building replacement products.

### *Exclusions*

This Guarantee does not apply to defects resulting from: improper or inadequate installation, use or maintenance; actions or modifications by unauthorized third parties or the end-user; accidental or willful damage or normal wear and tear.

### *Making a Claim*

Claims must be made in Latin America or the Caribbean by contacting the Dell point of sale within the guarantee period. The end-user must always supply proof of purchase, indicating name and address of the seller, date of purchase, model and serial number, name and address of the customer and details of symptoms and configuration at the time of malfunction, including peripherals and software used. Otherwise, Dell may refuse the guarantee claim. Upon diagnosis of a warranted defect, Dell will make arrangements, and pay for ground freight and insurance to and from Dell’s repair/replacement center. The end-user must ensure that defective product is available for collection properly packed in original or equally protective packaging together with the details listed above and the return number provided to the end-user by Dell.

### *Limitation and Statutory Rights*

Dell makes no other warranty, guarantee or like statement other than as explicitly stated above and this Guarantee is given in place of all other guarantees whatsoever, to the fullest extent permitted by law. In the absence of applicable legislation, this Guarantee will be the end-user’s sole and exclusive remedy against Dell or any of its affiliates, and neither Dell nor any of its affiliates shall be liable for loss of profit or contracts, or any other indirect or consequential loss arising from negligence, breach of contract, or howsoever.

**This Guarantee does not impair or affect mandatory statutory rights of the end-user against and/or any rights resulting from other contracts concluded by the end-user with Dell and/or any other seller.**

**Dell World Trade LP**

One Dell Way, Round Rock, TX 78682, USA

**Dell Computadores do Brasil Ltda (CNPJ No. 72.381.189/0001-10)/**

**Dell Commercial do Brasil Ltda (CNPJ No. 03 405 822/0001-40)**

Avenida Industrial Belgraf, 400

92990-000 - Eldorado do Sul – RS - Brasil

**Dell Computer de Chile Ltda**

Coyancura 2283, Piso 3- Of.302,

Providencia, Santiago - Chile

**Dell Computer de Colombia Corporation**

Carrera 7 #115-33 Oficina 603

Bogota, Colombia

**Dell Computer de Mexico SA de CV**

Rio Lerma #302- 4 Piso

Col. Cuauhtemoc, Mexico, D.F. 06500

***“Total Satisfaction” Return Policy (U.S. and Canada Only)***

If you are an end-user customer who bought new products directly from a Dell company, you may return them to Dell within 30 days of the date of invoice for a refund or credit of the product purchase price. If you are an end-user customer who bought reconditioned or refurbished products from a Dell company, you may return them to Dell within 14 days of the date of invoice for a refund or credit of the product purchase price. In either case, the refund or credit will not include any shipping and handling charges shown on your invoice. If you are an organization that bought the products under a written agreement with Dell, the agreement may contain different terms for the return of products than specified by this policy.

To return products, you must call Dell Customer Service to receive a Credit Return Authorization Number. Refer to the chapter titled “Getting Help” in your system's troubleshooting documentation or, for some systems, the section titled “Contacting Dell” in your system's online guide to find the appropriate telephone number for obtaining customer assistance. To expedite the processing of your refund or credit, Dell expects you to return the products to Dell in their original packaging within five days of the date that Dell issues the Credit Return Authorization Number. You must also prepay shipping charges and insure the shipment or accept the risk of loss or damage during shipment. You may return software for refund or credit only if the sealed package containing the diskette(s) or CD(s) is unopened. Returned products must be in as-new condition, and all of the manuals, diskette(s), CD(s), power cables, and other items included with a product must be returned with it. For customers who want to return, for refund or credit only, either applications software or an operating system that has been installed by Dell, the whole system must be returned, along with any media and documentation that may have been included in the original shipment.

This "Total Satisfaction" Return Policy does not apply to DellWare products, which may be returned under DellWare's then-current return policy. In addition, reconditioned parts purchased through Dell Spare Parts Sales in Canada are nonreturnable.

## ***Year 2000 Statement of Compliance for Dell-Branded Hardware Products***

Dell-branded hardware products shipped on or after January 1, 1997, are eligible to carry the "NSTL Hardware Tested Year 2000 Compliant" logo by virtue of formal testing with, and successful completion of, the National Software Testing Laboratories (NSTL) YMARK2000 test.\* Dell will treat a failure to pass the YMARK2000 test as a covered event under Dell's limited warranty for the product, subject to the normal warranty limitations.\*\* For a complete copy of Dell's limited warranty, see the product's documentation. Dell-branded hardware products will also recognize the year 2000 as a leap year.

\*The YMARK2000 standard tests the ability of system hardware and firmware to support the transition to the year 2000 (and to recognize leap years, when appropriate, for years 2000 through 2009 inclusive) and not that of options, operating systems, or applications software. Dell-branded hardware products that pass the YMARK2000 test conform to BSI-DISC PD 2000-1.

\*\* Except for this clarification of Dell's warranty for NSTL logo hardware, all other warranties, conditions and remedies, express or implied, relating to year 2000 readiness or compliance are disclaimed. To make a claim under this warranty for NSTL logo hardware, customers must contact Dell prior to January 1, 2001. To make a claim, write to:

Dell Computer Corporation  
P.O. Box 149258  
Austin, Texas 78714-9258  
Attention: Year 2000  
year2000@dell.com

Despite a system's ability to pass the YMARK2000 test, actual rollover results in specific operating environments may vary depending on other factors including, but not limited to, other hardware, operating systems, and applications software.

### ***Previous Products***

For Dell-branded hardware products shipped prior to January 1, 1997, that have an upgradable basic input/output system (BIOS), Dell makes available a BIOS upgrade. Although these products may not have been tested under the YMARK2000 test, Dell believes that the hardware would pass the YMARK2000 test, provided the appropriate BIOS upgrade is properly loaded.

For Dell-branded hardware products that do not have an upgradable BIOS, Dell has made available, as a convenience to customers, the Y2000RTC driver and the Dell **FIX2000.exe**, software utilities designed to assist customers in managing the year 2000 rollover.

## *Software*

Dell specifically excludes all non-Dell-developed software from this compliance statement. All software run on Dell-branded hardware products should be independently verified by customers to be year 2000-compliant.

The factory-installed software on your system is the current version provided by the software manufacturer and is validated by Dell for installation. Dell recommends that you check each software manufacturer's year 2000 Web site for updates to their products. Links to a number of these Web sites can be found at the Dell year 2000 Web sites.

## *Additional Information*

For additional information on year 2000 compliance of Dell-branded hardware products, refer to the following Dell year 2000 Web sites, or contact a Dell customer service representative in your area:

- **<http://www.dell.com/year2000>** (Americas)
- **<http://www.dell.com/jp/year2000>** (Japan)
- **<http://www.euro.dell.com/year2000>** (Europe)
- **<http://www.dell.com/ap/year2000>** (Asia Pacific)

